

SARAY®

all about **aluminium**

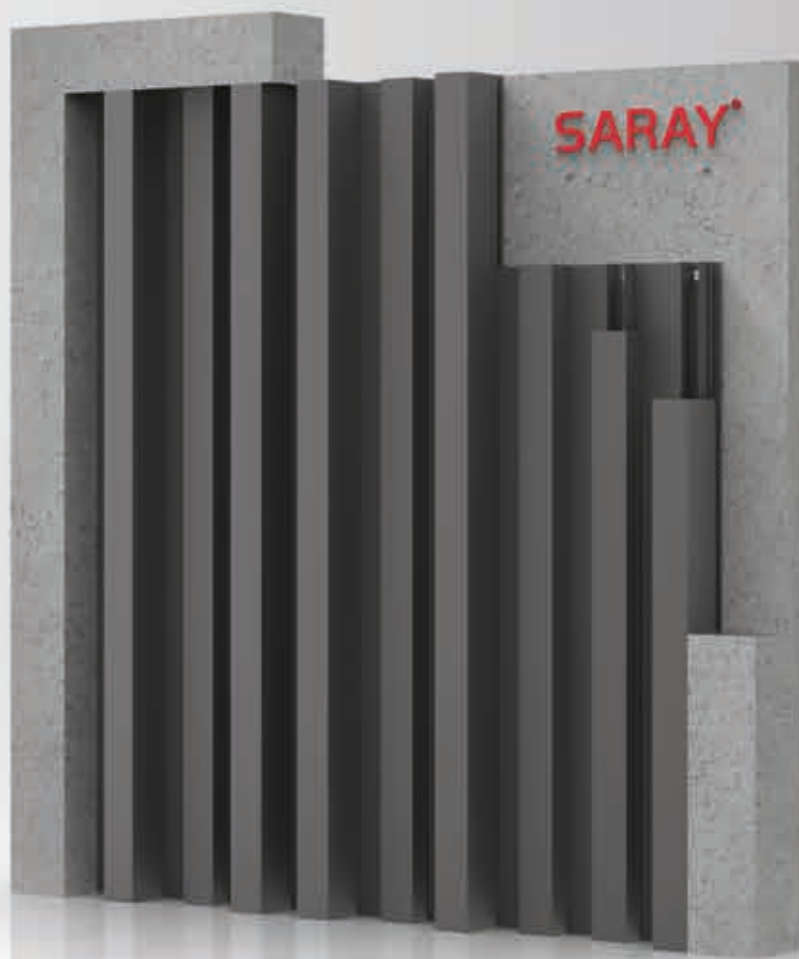

Cover profiles provide an
innovative appearance on facades

VERTICAL



Diğer cephe kaplama yapı elemanlarına göre daha hafif yapıya sahip olması, köşe dönüştürme alanlarında özel çözüm detayları sunması ile yapıyı tamamen saran bir kabuk olarak yer alabilmesi, sistemin diğer alternatif cephe kaplama çözümlerinin ötesinde tercih edilen bir sistem olmasını sağlamaktadır.

Uygulama kolaylığı ile cephelere hızla yenilikçi ve modern bir görünüm sağlayan sistem, RAL kartelasında bulunan tüm renklere boyanabildiği gibi, eloksal yüzey işlem ve ahşap desen renk seçenekleri sayesinde, mimarlara tasarladıkları yapılarda istedikleri tarz cephe kurgusu yaratma kolaylığı da sunar.

Farklı ebattaki kapak profillerinin bir arada kullanımına izin veren sistem, cephelerde birbirinden bağımsız tasarımlar da oluşturulmasına izin vererek yaratıcılığı destekler.

VERTICAL is a lightweight system compared to other facade cladding elements. It offers special solution details for corner areas and can envelop the building like a shell. This makes it a preferred choice beyond alternative facade cladding solutions.

The system provides an innovative and modern look to facades with easy application. It can be painted in all colors from the RAL color chart and offers options for anodized surface treatment and wood pattern color choices, allowing architects to create the desired facade design.

With the ability to use different-sized cover profiles together, the system supports the creation of independent designs on facades, fostering creativity in architectural solutions.





TEKNİK ÖZELLİKLER - TECHNICAL PROPERTIES

İstenilen renk ve desen ile sonsuz çeşitte kombinasyonlar yapılır.
Gizli montaj detaylarına sahiptir.
Kolay imalat ve montaj detayı vardır.
Tüm yapıyı bir kabuk olarak sarar, yapıları yeni bir kimlik kazandırır.
Kapı ve pencereler ile entegre edebilir.
Mimariye tasarımda özgürlük kazandırır.
Açılı dönüşlere izin verir.
Hafifliği ile yapıları ek yük getirmez.
Yapı kabuğunu olumsuz dış etkilere karşı korur.
Yapıların dış mekanlarının yanında iç mekanda da kullanılabilir

Endless kinds of combinations are made with the desired color and pattern.
It has hidden mounting details.
There are easy manufacturing and assembly details.
It wraps the entire structure as a shell, giving a new identity to the structures.
Can integrate with doors and windows.
Gives architecture freedom in design.
Allows angled turns.
With its light weight, it does not bring additional load to the structures.
Protects the building shell from negative external influences.
It can be used indoors as well as outdoors of buildings

TEKNİK ÇİZİMLER - TECHNICAL DRAWING

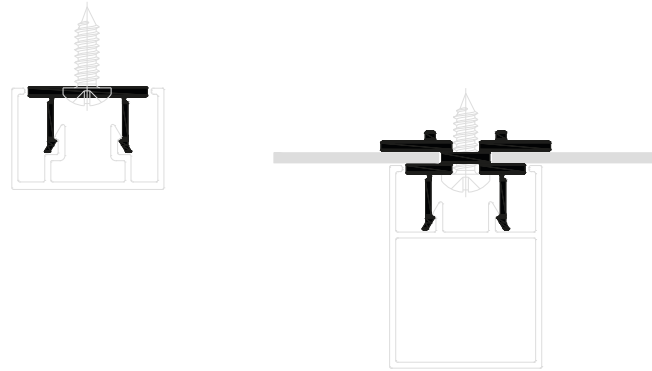
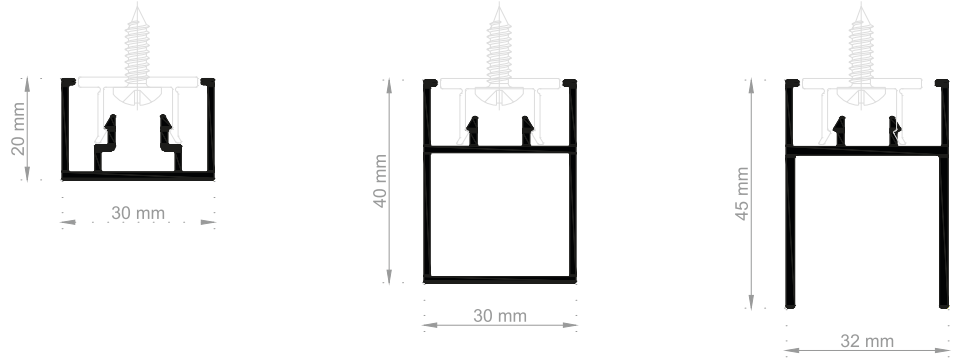

SVC01: 20 mm x 30 mm ebatlarında kapak profili: İnce düşey hatlar ile zarif cephe kurgusu.

SVC02: 40 mm x 30 mm ebatlarında kapak profili: Cephede baskın profil etkisi ile yapıya yeni bir katman kazandırır.

SVC03: 45 mm x 32 mm ebatlarında içi boşluklu kapak profili: İçi boşluklu yapısı sayesinde farklı gölgelermeler ve cephede zengin bir görünüm sağlar.

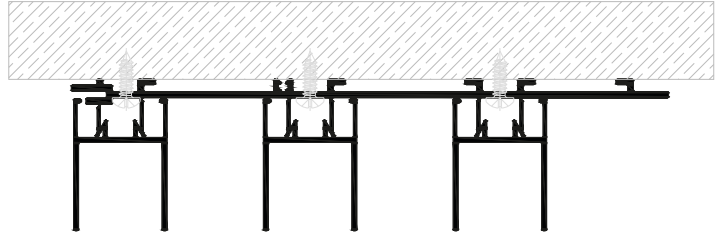
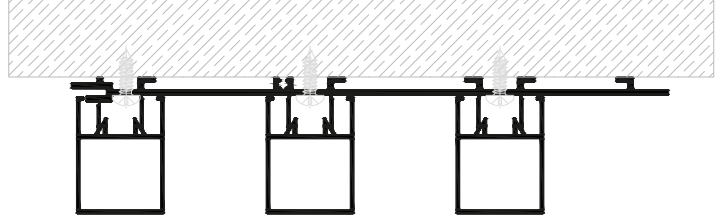
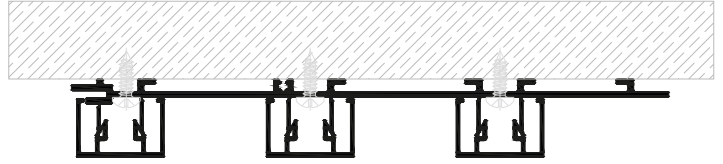

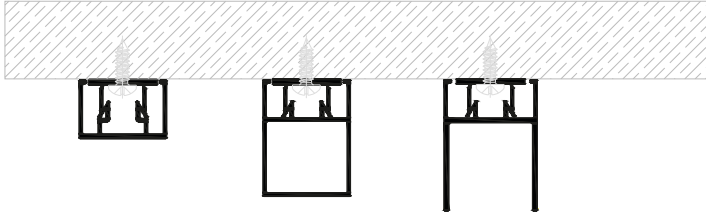

SVC04: tekil olarak kapak profilleri ile kullanılabilen versiyon
SVC04: the version that can be used individually with cover profiles

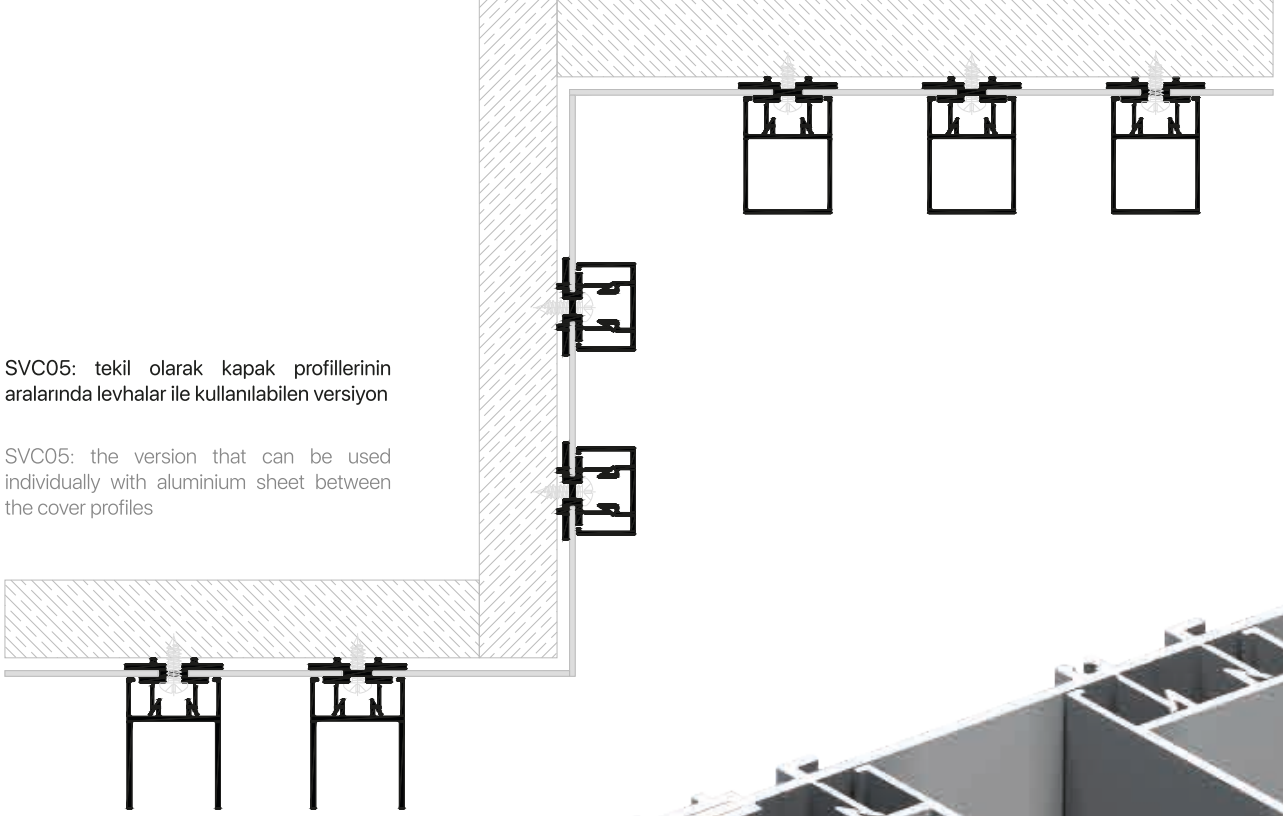

SVC05: tekil olarak kapak profillerinin aralarında levhalar ile kullanılabilen versiyon

SVC05: the version that can be used individually with aluminium sheet between the cover profiles

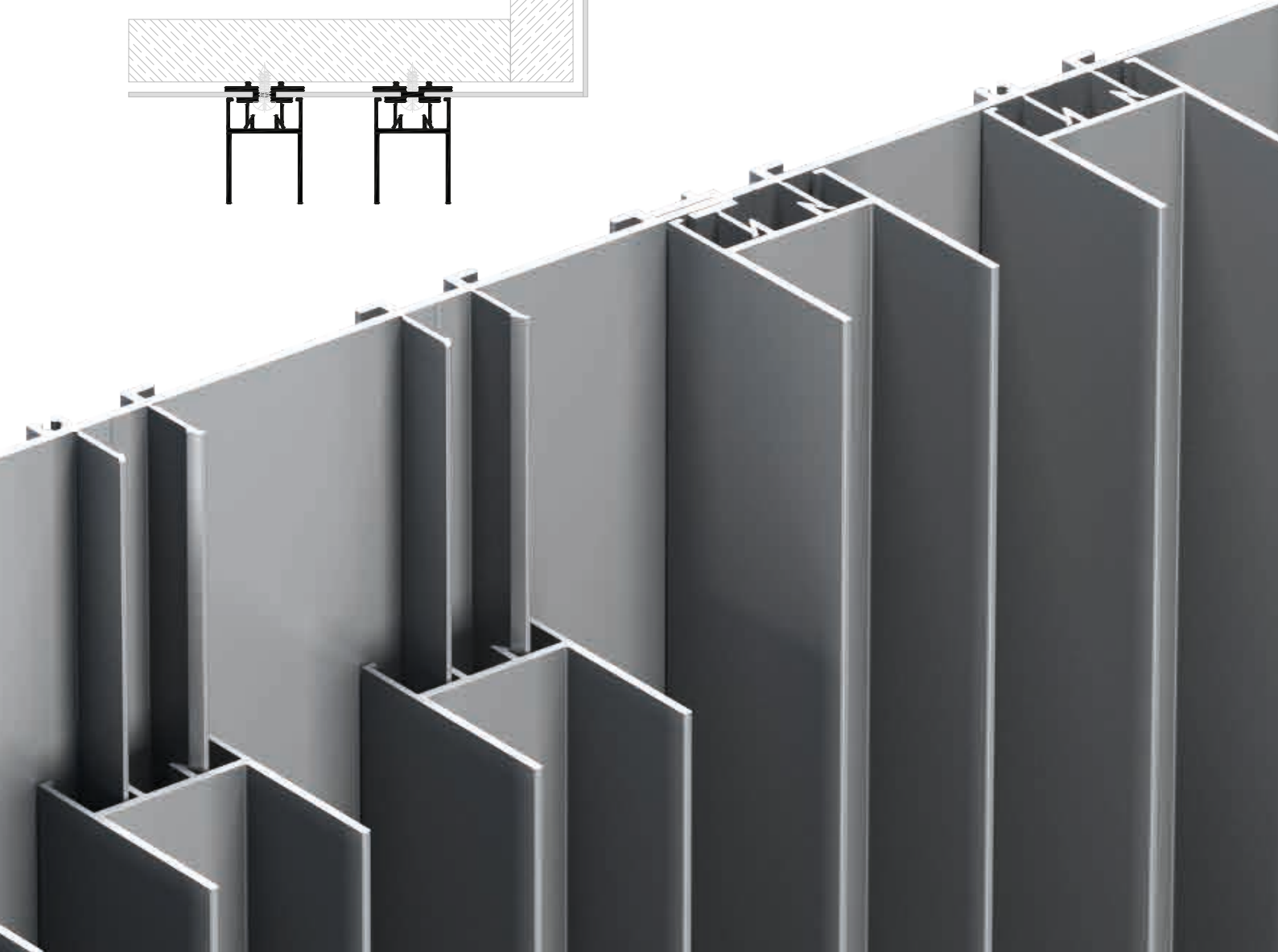

since

1980

www.saray.com

TR | ENG



VERTICAL

Kaplama Sistemleri | Cladding Systems
Copyright: SARAY BLC.v2 | 10.2023

SARAY DÖKÜM ve MADENİ AKSAM SAN. TUR. A.Ş.